

# ONE ZERO

REF. 2848

## Programmable terrestrial filtering header





# Contents

## **4 General safety instructions**

- 4 Types of notices
- 5 Basic safety instructions

## **6 Introduction**

- 6 General description
- 6 Main features
- 7 General use of the unit

## **9 Unit installation and configuration**

- 9 Installation
- 9 Power connection
- 10 Fast menu guide
- 11 Language selection
- 11 Manual setting
- 13 Advanced settings
- 15 Self-installation

## **16 Maintenance**

- 16 Unit care
- 16 Troubleshooting

## **17 Technical specifications**

- 17 ONE ZERO Model (FFP-110)

## **18 Technical appendix**

## **19 Warranty**

## **20 Unit recycling**

## **21 CE Certificate**

# General safety instructions

- Read all of this user manual carefully before plugging in the unit.
- Always have these instructions to hand during installation.
- Follow all of the instructions and safety notices regarding unit handling.

## Types of notices

The meaning of the safety notices used in this manual are described below.



### DANGER OF DEATH OR INJURY

This safety notice indicates a possible danger for the life and health of people. Not following these instructions may lead to serious consequences to health and may even cause fatal injuries.



### RISK OF DAMAGE TO THE UNIT

This safety notice indicates a possible dangerous situation. Not following these instructions may lead to the unit being damaged.



### NOTE

This type of notice is a note containing applicable advice and useful information for optimum use of the unit.



### HANDLING THE INSIDE OF THE UNIT IS FORBIDDEN

This notice forbids any work that may affect the working order of the unit or its warranty.



### DO NOT DISPOSE OF AS URBAN WASTE

This type of notice indicates that the unit must not be disposed of as unselected urban waste.

## Basic safety instructions



### DANGER OF DEATH OR INJURY

- Do not install the unit during an electrical storm. This could lead to electrostatic discharge from lightning.
- Do not open the unit. There is a risk of electrostatic discharge.



### RISK OF DAMAGE TO THE UNIT

- The unit must be appropriately ventilated. Install the unit in a dust-free location. Do not place the unit in a location where the ventilation slots are covered or blocked. Install the unit in a location with at least 20 cm around it free of other objects.
- Do not expose the unit to rain or moisture. Install the unit in a dry location with no water infiltrations or condensation. Should a liquid enter the unit, disconnect it immediately from the mains.
- Keep the unit away from flammable objects, candles and anything that may cause a fire.
- Connect the unit to an easily accessible power socket. In the event of an emergency, it will then be possible to quickly unplug the unit.
- Do not expose the unit to sources of heat (sun, heating, etc.).

# Introduction

## General description

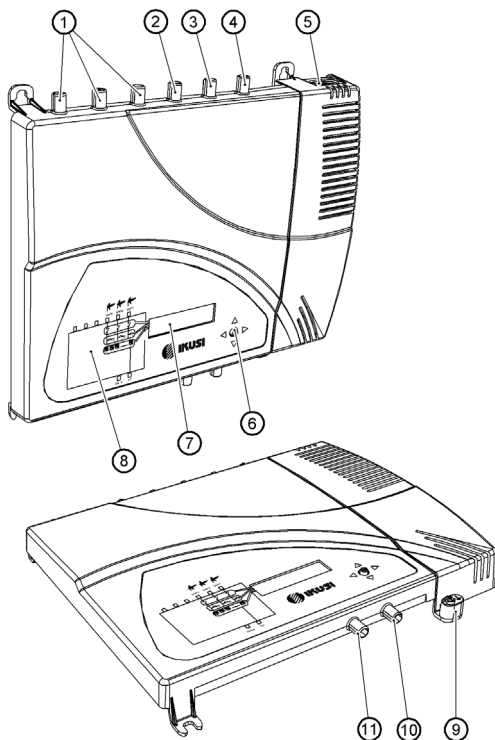

### KEY

- ① Unavailable inputs
- ② UHF3 input
- ③ UHF2 input
- ④ UHF1 input
- ⑤ Mains connector
- ⑥ Control button
- ⑦ Screen (LCD)
- ⑧ Front panel with cluster map
- ⑨ Earthing
- ⑩ TV outlet
- ⑪ Cloning connector

## Main features

The ONE ZERO model is a programmable terrestrial filtering header, designed to selectively filter analogue and digital UHF channels. It is suitable for individual and collective dwellings and it is the ideal solution to correctly equalise television channels that come through the aerial with different frequencies and amplitudes.

The ONE ZERO model has 10 tuneable UHF filters that can process between 1 and 5 channels each. Individual adjustment of each frequency filter, number of channels and automatic gain control allows for level equalisation of selected channels.

- Programming:
  - Self-installation function.
  - All settings are automatically memorised.
  - No external programmer required, programmed directly from the headend.

- Reprogrammable as many times as required.
- 10 tuneable UHF filters that can each process between 1 and 5 channels.
- Signal processing:
  - UHF inputs with low noise figure (< 6 dB).
  - Automatic signal level equalisation.
  - Automatic gain control.
- Extra functions:
  - Internal configuration cloning with transferral between units.
  - Unit locking by security code.
- Dimensions: 300 mm x 250 mm x 41 mm
- Weight: 2.2 kg

## General use of the unit

Interaction with the unit using the control button and how to interpret the instructions displayed on the LCD screen are described below. The programme includes a main menu formed by submenus that can be selected to modify the unit operating settings.

### Instructions displayed on the LCD screen



This symbol is displayed when manual setting is selected. It refers to the clusters indicated on the panel.

---



This symbol is displayed in the manual setting menu. Visually locate it on the LCD screen and see the cluster map on the panel to see which of the 3 unit clusters is selected.

---



This acronym appears on the main menu. Select it to return to the language selection menu.

---



This symbol is displayed in manual settings and advanced settings and visually indicates the possibility of moving vertically.

---



This symbol is displayed in manual and advanced settings and always includes a numeric value and visually indicates the gain level.

---



This icon is displayed with the unit lock enabled when the unit is switched on and after periods when the unit is not in use.

---

## Vertical button movement



In the menus and submenus, move the button up or down to browse upwards and downwards position by position.

---

In the settings, move the button up or down to modify values position by position.

---



### NOTE

Keep the button pressed up or down to browse or to modify values more quickly.

## Horizontal button movement



In the menus, move the button to the left or the right to select and go back position by position.

---

In the settings, move the button to the left or the right to select and go back position by position.

---



### NOTE

Keep the button pressed to the left or to the right to browse more quickly.

## Press button



In the menus, this selects the submenu.

---

In the submenus, this selects the setting.

---

In the settings, this selects the parameter value.

---



# Unit installation and configuration

Only the LCD screen and the control button are required to configure the unit. Follow the steps below to install the unit and configure the different parameters.

## Installation



### RISK OF DAMAGE TO THE UNIT

Mechanical handling of the unit while it is switched on may lead to it being damaged. Do not plug the unit into the mains before or during installation.

- 1) Fit and tighten the bolts and plugs securing the unit to the wall.
- 2) Connect the coaxial cable from the aerial to the unit.
- 3) Connect the coaxial cable from the outlet to the unit.

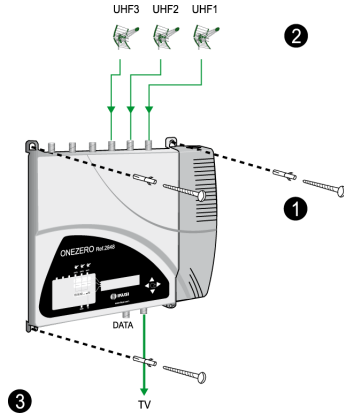

## Power connection



### DANGER OF DEATH OR INJURY

Incorrect unit power connection may cause an electric shock. Follow the steps below for the electrical installation of the unit.

- 1) Connect the earthing cable.
- 2) Connect the power plug to the unit mains connector.
- 3) Connect the power plug to the mains socket.

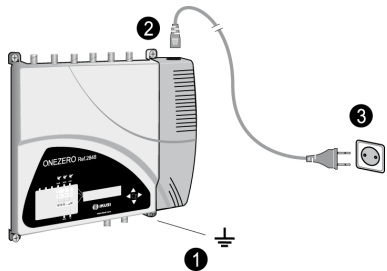

## Fast menu guide

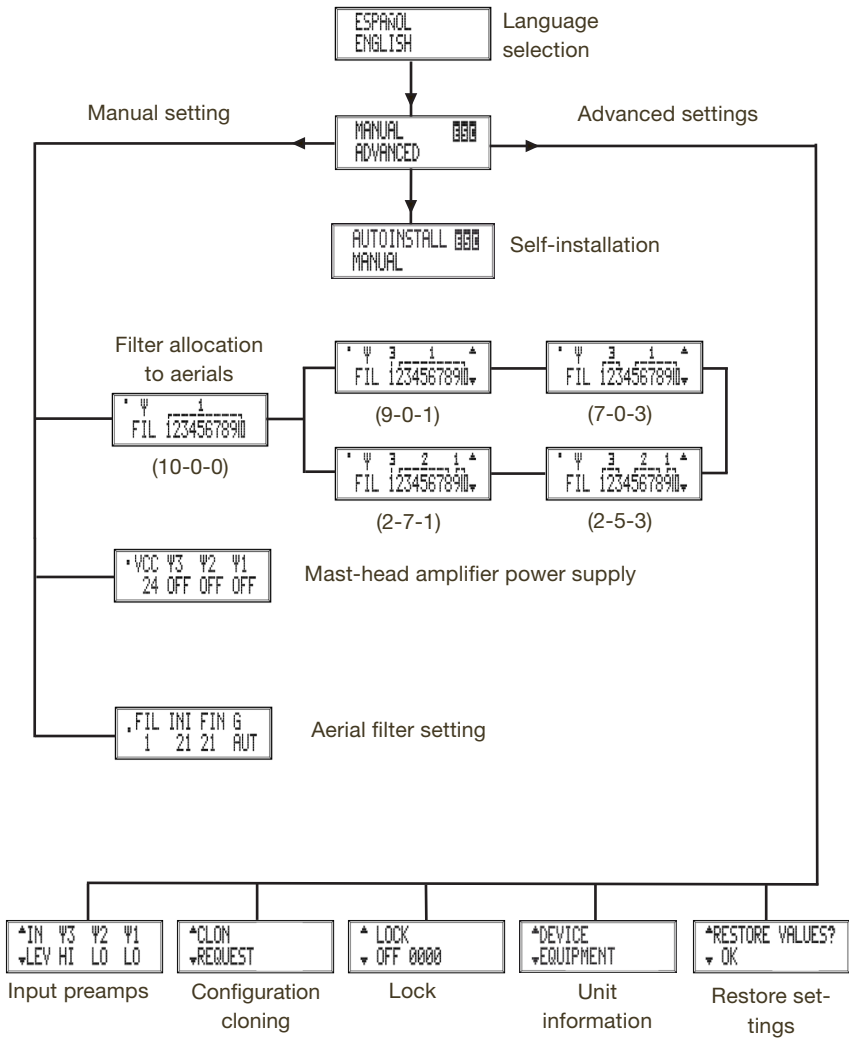

## Language selection



### NOTE

Over the following pages, the field locating and selection method is primarily indicated by the “vertical button movement” and “press button” icons. However, horizontal button movement can be used to locate and select fields, as indicated in the [General use of the unit](#).



### NOTE

The unit automatically accesses language selection a few sections after the welcome message is displayed. Language selection can also be accessed by going back from the main menu.

- 1) Locate and select the language:  
ESPAÑOL – ENGLISH – FRANÇAIS.
- 2) Access the main menu.



## Manual setting

- 1) In the main menu, locate and select MANUAL.



### NOTE

The cluster map on the unit panel indicates the cluster related to each submenu.



## Filter allocation to aerials



### NOTE

There are five different configurations to distribute the 10 filters among the 3 aerials.

- 1) Locate and select the aerial filter configuration (the aerial distribution is displayed at the top of the screen and the 10 filters available are displayed at the bottom):
  - For one aerial:
    - a) Configuration (10 – 0 – 0)

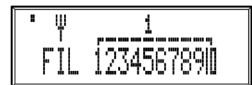

■ For two aerials:

b) Configuration (9 – 0 – 1)



c) Configuration (7 – 0 – 3)



■ For three aerials:

d) Configuration (2 – 5 – 3)



e) Configuration (2 – 7 – 1)

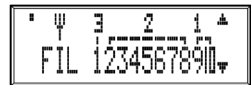

### Mast-head amplifier power configuration



**NOTE**

Only where a mast-head amplifier is fitted to the aerial.

1) Locate and select the UHF input voltage: VCC, 24 / 12.



2) Locate and select UHF input voltage enabling (ON) / disabling (OFF):

- a) UHF3 input voltage: Ψ3, ON / OFF
- b) UHF2 input voltage: Ψ2, ON / OFF
- c) UHF1 input voltage: Ψ1, ON / OFF

### Filter adjustment

#### Frequency configuration

1) Locate and select the filter to adjust: FIL, 1 – 10.



2) Locate and select the filter start channel: INI, 21 – 69.

3) Locate and select the filter end channel: FIN, 21 – 69.

**Gain configuration:****NOTE**

If AUT is selected, the unit adjusts the gain automatically and completes gain configuration for the filter selected. If M is selected, you adjust the gain manually.



```
.FIL INI FIN G
1 21 21 M
```

- 1) Locate and select the gain configuration mode AUT / M.
  - a) If AUT is selected: self-equalising is configured.
  - b) If M is selected: find and select the level of gain in the 00 - 30 range.



```
.FIL INI FIN G
1 21 25 19
```

**Advanced settings**

- 1) In the main menu, locate and select ADVANCED.



```
MANUAL
ADVANCED
```

**Input preamps****NOTE**

The difference in gain between an enabled and a disabled amplifier is 20 dB. Select LO to enable an amplifier.

If the gain is set to automatic in filter configuration, the system manages preamp enabling according to the input level.

- 1) Locate and select UHF input preamps:
  - a) UHF3 input:  $\Psi$ 3, HI / LO.
  - b) UHF2 input:  $\Psi$ 2, HI / LO.
  - c) UHF1 input:  $\Psi$ 1, HI / LO.



```
^IN  $\Psi$ 3  $\Psi$ 2  $\Psi$ 1
vLEV HI LO LO
```

**Unit configuration cloning****NOTE**

Cloning begins automatically after the following steps.



```
^CLON
vREQUEST
```

- 1) Connect two units using a coaxial cable through the cloning output on each unit (see position 11 on the illustration in the [General description](#) section).
- 2) On the unit receiving the information: locate and select MASTER OFF, SLAVE ON.



```
^MASTER SLAVE
v OFF ON
```

- 3) On the unit sending the information: locate and select MASTER ON, SLAVE OFF.



**NOTE**

The time waited for cloning to be run is 11 seconds. Where cloning cannot be started, the unit returns to the higher menu.



### Unit locking



**NOTE**

The lock is enabled when the unit is re-connected.

- 1) Find and select:

LOCK, ON

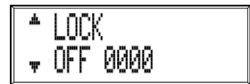

- 2) Enter a 4-digit sequence:

LOCK, 0000.



**NOTE**

To unlock the unit, enter and select the 4-digit sequence on the start screen. To cancel unit locking, locate and select LOCK, OFF. If you forget the 4-digit sequence, see: [Troubleshooting](#).



### Specific unit information



**NOTE**

Information on the unit, the programme version, the manufacturing date, the number of hours operating, the temperature and the unit serial number are displayed on the screen.



### Restore factory settings



**CAUTION**

This function will mean that all previous configurations will be lost and the factory settings will be restored.



- 1) Select OK to restore factory settings.



## Self-installation



### NOTE

The unit automatically configures the optimum operating frequency and gain of the UHF filters. The unit does not automatically configure the output level of general gains.

- 1) In the main menu, locate and select AUTOINSTALL.



AUTOINSTALL   
MANUAL

- a) If NO is selected: you will return to the main menu.



BEGIN AUTO  
YES NO

- b) If YES is selected: self-installation will begin.

SCANNING  
AERIAL 1.



### NOTE

The unit displays information on the status of self-installation. Please wait a few seconds until it is completed and AUTOINSTALL. COMPLETED is displayed.

EQUALIZING  
FILTERS.

- 2) Select OK to complete self-installation.
- 3) To review the allocation of filters to aerials, see: [Filter allocation to aerials.](#)



AUTOINSTALL  
CLOMPLETED

# Maintenance

## Unit care



### HANDLING THE INSIDE OF THE UNIT IS FORBIDDEN

Do not dismantle or try to repair the unit, its accessories or its components. This will render the warranty null and void.

- Do not use the power cable if it is damaged.
- To disconnect the power cable, pull carefully on the plug and never on the cable.
- To clean the panel and unit connections:
  - Unplug the unit.
  - Clean with a slightly damp, soft cloth.
  - Allow to dry completely before use.
- Do not spill liquid onto the unit.
- Keep ventilation slots free of dust or any foreign bodies.

## Troubleshooting

The most frequent problems arising during unit installation are indicated below. If you encounter any other type of problem, please contact the unit sales team.

Problem	Possible cause	What to do
Forgotten unlock code.	-	Contact your point of sale.
Nothing displayed on LCD screen.	The power cable is not connected properly.	Check the power cable.
The channels do not adjust to the programmed output level.	Lack of signal or unsuitable channel level.	Check that the channel programmed as the highest output channel has a signal and appropriate level. This is used as a reference for output level adjustment.



# Technical specifications

## ONE ZERO Model (FFP-110)

Inputs		UHF1	UHF2	UHF3
		3		
Band width	MHz	470-862		
		10	0	0
		9	0	1
Input configuration		7	0	3
Number of programmable UHF filters per input		2	5	3
		2	7	1
Gain	dB	0		
Gain adjustment	dB	30 adjustable + 20 step		
Noise figure	dB	<6		
Optimum input margin	dB $\mu$ V	50-80 70-100		
Return losses	dB	>10		
Selectivity ( $\pm$ 10 MHz of channel ends)	dB	10		
Uncoupling between inputs	dB	>20		
AGC precision	dB	$\pm$ 1		
Switchable preamp voltage	V	12-24		
Maximum preamp current	mA	100		

### Operations

Mains voltage	230 - 240 V~
Consumption	0.05 A / 12 W
Operating temperature	-5 to 50 °C
Mains connector	IEC C8

# Technical appendix

## RF output level reduction table in Broadband Amplification

**TERRESTRIAL TV BROADBAND AMPLIFIERS** The RF output levels specified in the manual for an IMD3 intermodulation distance of -60dB according to DIN 45004B, are applicable when 2 analogue TV channels are amplified. If more than 2 channels are amplified, these levels should be reduced as indicated in the table below::

Number of channels (n)	2	3	4	5	6	7	8	9	10	15	20
Output level reduction = 7.5 · log (n-1) dB	0	2	3,5	4,5	5	5,5	6	6,5	7	8,5	9,5

**COFDM SIGNALS:** If the maximum levels for the terrestrial Digital TV (COFDM) signals are set to 10 dB or more below the level of the analogue TV signals, these signals can be ignored to the effects of output level reduction; if this is not the case, they should be considered to be analogue TV channels.

**TERRESTRIAL DIGITAL TV BROADBAND AMPLIFIERS:** The RF output levels specified in the manual for an IMD3 intermodulation distance of -35dB according to EN 50083-3, are applicable when 1 analogue TV channel modulation FM, QPSK or COFDM is amplified. For a greater number of channels, these levels should be reduced as indicated in the table below:

Number of channels (n)	2	3	4	5	6	7	8	9	10	15	20
Output level reduction = 10 · log n dB	3	4,5	6	7	8	8,5	9	9,5	10	11,5	13

**REDUCTION DUE TO CASCADING ASSEMBLY:** When n equal broadband amplifiers are installed in a cascade, consider an additional reduction in the output level equal to 10 · log n on each and every one of them.

## Warranty

Notwithstanding any complaints made to the direct vendor of the product, IKUSI offers unit users a two-year warranty as of the invoice date, which shall become valid on presenting the receipt of purchase.

During the warranty period, IKUSI is responsible for any faults arising due to material or manufacturing defects and shall repair the receiver or replace it for another corresponding to the state of technology at that time. The warranty does not cover any faults or defects due to misuse or non-fulfilment of the information given in this installation manual.

All complaints other than those indicated are not included in the warranty. More specifically, the warranty does not cover services provided by the authorised vendor (e.g. installation, configuration or program updates) or the repair of any damages or injuries caused to the client or others as a result of the installation or of receiver operations.

# Unit recycling



## RECYCLING OF ELECTRICAL AND ELECTRONIC EQUIPMENT

**(Applicable in the European Union and in European countries with selective waste collection systems.)**

This symbol on your unit or its packaging indicates that this product cannot be treated as general domestic waste and must be handed in at the corresponding point of collection for electric and electronic equipment. By ensuring this product is disposed of correctly you will help prevent negative consequences for the environment and human health, which could otherwise be caused by inappropriate waste handling of this product. Recycling of materials helps preserve natural resources. For more detailed information on the recycling of this product, please contact your local council, your nearest collection point or the distributor from whom you purchased the product.

# CE Certificate

By reproducing the CE marking, IKUSI guarantees unit compliance with the corresponding harmonised standards.

## EC-Declaration of Conformity

**CE** marking

We, Manufacturer

IKUSI, **Angel Iglesias, S.A.**  
Paseo Miramón, 170  
E-20009 San Sebastián, Spain

declare that the product

**Programmable Filters Equipment  
ONE ZERO**

is in conformity with

**Council Directive 2004/108/CE  
(EMC Directive)**

Standards to which conformity is declared :

**EN 50083-2** :2007

Cable networks for television signals, sound signals and interactive services. Part 2: Electromagnetic compatibility for equipment.

and

**Council Directive 2006/95/CE  
(Low Voltage Directive)**

Standards to which conformity is declared :

**EN 60728-11** :2005

Cable networks for television signals, sound signals and interactive services. Part 11: Safety.

**EN 60065** :2003

Audio, video and similar electronic apparatus. Safety requirements.



**Angel Iglesias, S.A.**

San Sebastián, October 2009

Luis Rodríguez Navarrete

— R&D Director —



Ángel Iglesias, S.A.  
Paseo Miramón, 170  
20009 San Sebastián, Spain  
Tel. +34 943 44 88 00  
Fax +34 943 44 88 20  
ikusi@ikus.com  
www.ikus.com

120116A

